

Panasonic[®]

Operating Instructions

COMBI WAVE[™]

Commercial Microwave Convection Oven

NE-C1153

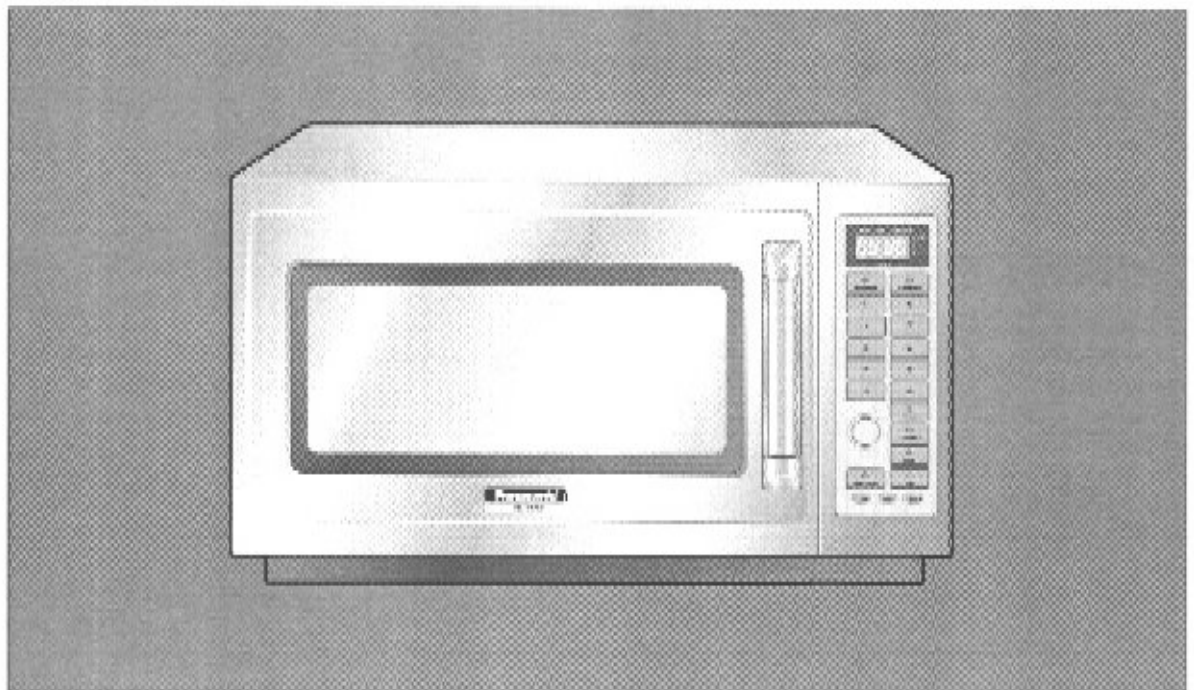

Please read these instructions completely before operating this oven.

Before Calling for Service:

If failure code "F" appears in the display, unplug oven and wait 1 minute before reconnecting. If normal operation does not resume, call the service agent with the information of failure code. (See page 23.)

Contents

PRECAUTIONS TO AVOID POSSIBLE EXPOSURE TO EXCESSIVE MICROWAVE ENERGY3
IMPORTANT SAFETY INSTRUCTIONS3
Installation and Grounding Instructions4
Caution5
How to install the Air Screen5
Outline Diagram6
Display Window7
Control Panel7
How to Operate	
Operating Oven in Microwave mode8
Operating Oven in Convection mode10
Operating Oven in Combination mode12
Setting the Memory Programs14
Using the Memory Programs15
How to activate the Program Lock16
How to release the Program Lock17
How to read the Program List17
Keeping the Oven Hot18
Cooling the Oven quickly19
How to change the Beep Tone20
How to read the Cycle Counter21
How to program for Scheduled Cleaning Service22
Sanitary Counter Top Seal23
Self Diagnostics Failure Code Explanation23
Taking Care of Your Oven24
How Does The Microwave Work?27
Types of Containers to use28
Cooking Instructions29
Technical Specifications30

Owner's Record

Model No. _____

Serial No. _____

The serial number of this product can be
found on the lower right hand side of the oven.

Dealer's Name _____

Dealer's Address _____

Date of Purchase _____

See page 23 before calling

Toll Free Service Information

To locate a convenient service agent call

1-888-350-9590

Chef Support: 201-348-7305

www.panasonic.com/cmo

Virtual Test Kitchens

PRECAUTIONS TO AVOID POSSIBLE EXPOSURE TO EXCESSIVE MICROWAVE ENERGY

- (a) Do not attempt to operate this oven with the door open since open-door operation can result in harmful exposure to microwave energy. It is important not to defeat or tamper with the safety interlocks. Under normal conditions, the oven will not operate with the door open.
- (b) Do not place any object between the oven front face and the door, or allow soil or cleaner residue to accumulate on sealing surfaces.
- (c) Do not operate the oven if it is damaged. It is particularly important that the oven door closes properly and that there is no damage to the:
 - (1) door (bent)
 - (2) hinges and latches (broken or loose)
 - (3) door seals and sealing surfaces.
- (d) The oven should not be adjusted or repaired by anyone except properly qualified service personnel. (See page 2.)

IMPORTANT SAFETY INSTRUCTIONS

Your microwave oven is a cooking device and you should use as much care as you use with a stove or any other cooking device. When using this electric appliance, basic safety precautions should be followed, including the following:

WARNING—To reduce the risk of burns, electric shock, fire, injury to persons, or exposure to excessive microwave energy:

1. Read all instructions before using the appliance.
2. Read and follow "PRECAUTIONS TO AVOID POSSIBLE EXPOSURE TO EXCESSIVE MICROWAVE ENERGY," above on this page.
3. This appliance must be grounded. Connect only to a properly grounded outlet. See "Grounding Instructions" found on page 4.
4. Install or locate this appliance only in accordance with the provided installation instructions, found on page 4.
5. Do not cover or block any openings on this appliance.
6. Do not store or use this appliance outdoors. Do not use this product near water—for example, near a kitchen sink, in a wet basement, or near a swimming pool, and the like.
7. Use this appliance only for its intended use as described in this manual. **DO NOT** use corrosive chemicals, vapors, or non-food products in this appliance. This type of oven is specifically designed to heat or cook. It is not designed for industrial or laboratory use. The use of corrosive chemicals in heating or cleaning will damage the appliance and may result in radiation leaks.
8. When cleaning surfaces of door and oven that come together on closing the door, use only mild, non-abrasive soaps or detergents applied with a sponge or soft cloth.
9. Do not allow children to use this appliance, unless closely supervised by an adult.
10. Do not operate this appliance if it has a damaged cord or plug, if it is not working properly, or if it has been damaged or dropped.
11. Do not immerse cord or plug in water.
12. Keep cord away from heated surfaces.
13. Do not let cord hang over edge of table or counter.
14. This appliance should be serviced only by qualified service personnel. Contact the nearest authorized service facility for examination, repair or adjustment.
15. Some products such as whole eggs, narrow neck bottles and sealed containers - for example, closed glass jars - may explode and should not be heated in this oven.
16. To reduce the risk of fire in the oven cavity:
 - (a) Do not overcook food. Carefully attend appliance if paper, plastic, or other combustible materials are placed inside the oven to facilitate cooking.
 - (b) Remove wire twist-ties from paper or plastic bags before placing bag in oven.
 - (c) **If materials inside the oven should ignite, keep oven door closed, turn oven off, and disconnect the power cord, or shut off power at the fuse or circuit breaker panel.**
 - (d) Do not use the cavity for storage purposes. Do not leave paper products, cooking utensils, or food in the cavity when not in use.
17. Liquids, such as water, coffee, or tea are able to be overheated beyond the boiling point without appearing to be boiling due to surface tension of the liquid. Visible bubbling or boiling when the container is removed from the microwave oven is not always present. **THIS COULD RESULT IN VERY HOT LIQUIDS SUDDENLY BOILING OVER WHEN A SPOON OR OTHER UTENSIL IS INSERTED INTO THE LIQUID.** To reduce the risk of injury to persons:
 - (a) Do not overheat the liquid.
 - (b) Stir the liquid both before and halfway through heating it.
 - (c) Do not use straight-sided containers with narrow necks.
 - (d) After heating, allow the container to stand in the microwave oven for a short time before removing the container.
 - (e) Use extreme care when inserting a spoon or other utensil into the container.
18. The outside of microwave oven becomes very hot when the convection and combination stages are being used. With the exception of the door handle and control panel, **DO NOT** touch the outside surface of the microwave oven, including the front door, while the convection and combination stages are being used.

SAVE THESE INSTRUCTIONS

For proper use of your oven read remaining safety cautions and operating instructions.

Installation and GROUNDING INSTRUCTIONS

Examine your Oven

Unpack oven, retain all packing material, and examine the oven for any damages such as dents, broken door latches or cracks in the door. Notify supplier immediately if unit is damaged. DO NOT install if unit is damaged.

Note: The appliance should be inspected for damage to the door seals and door seal areas. If these areas are damaged, the appliance should not be operated, until it has been repaired by a service technician trained by the manufacturer.

Removal of Protective Film

A protective film is used to prevent scratching of the outer case during transportation. Remove this film before installation or use.

Placement of the Oven

Oven must be placed on a flat, stable surface. For proper operation, the oven must have sufficient air flow. A gap of at least 2 inches must be available at the right, left sides and back wall of the oven. A minimum space of 8 inches must be left above the oven and the 2 exhaust vents at the rear.

There should be no gap between the table surface and the bottom of the oven. (See instructions "Sanitary Counter Top Seal" on page 23.) Do not place the oven in a hot or damp area, ie. near a stove, sink or directly above heat lamps on a serving line. There is a possibility of a small amount of interference with weak broadcast signals if the microwave oven is located too close to a radio or TV.

Air vents

This oven requires free airflow at the back for maximum cooling efficiency.

Do not block the air vents.

Maximum room temperature

Do not operate the oven when the room temperature is higher than 105°F and/or the humidity is higher than 90%. Free airflow around the oven is important.

Outdoor use

Do not use this oven outdoors.

Shelves

Do not place the oven directly above or beside a gas or electric range, the oven may be damaged. It is dangerous to position this oven on a shelf which is so high that food and accessories cannot be safely inserted or removed by the user.

Stacking

DO NOT attempt to stack these ovens.

Grounding Instructions

This oven must be electrically grounded. In the event of an electrical short circuit, grounding reduces the risk of electric shock by providing an escape wire for the electric current. The appliance is equipped with a cord having a grounding wire with a grounding plug. The plug must be plugged into an outlet that is properly installed and grounded.

WARNING — Improper use of the grounding plug can result in a risk of electric shock.

Consult a qualified electrician or service person if the grounding instructions are not completely understood, or if doubt exists as to whether the appliance is properly connected.

Do not use an extension cord. If the power supply cord is too short, have a qualified electrician or serviceman install an outlet near the appliance.

Wiring Requirements

No other appliance should share the circuit with the microwave convection oven. If it does, the branch circuit fuse may overload and either cause the oven to produce lower power output or blow the fuse.

1. This oven must be operated on a dedicated, separate 60 Hz GROUNDED CIRCUIT - minimum 20 amps.
2. This oven is built to operate only on a 208 V power supply. Using a power supply voltage higher than 208 V is dangerous and may result in overheating of the electrical components, thus shortening their life expectancy or possibly causing a fire or another incident.

Panasonic is NOT responsible for any damages resulting from the use of the oven with any voltage other than specified.

NEMA#
6-20P



208 V
Grounded Outlet
NEMA# 6-20R

Caution

Before Use

Before using CONVECTION or COMBINATION function for the first time, operate this oven without food on Convection 500°F for 20 minutes, removing all accessories from the oven. This will cause the oil that is used for rust protection to be burned off.

Operation when empty

DO NOT operate the oven empty in the microwave mode. The microwave energy will reflect continuously throughout the oven causing overheating, if food or water is not present to absorb energy. This could damage the oven and result in a risk of fire.

Service

DO NOT tamper with or make any adjustments or repairs to door, control panel housing, safety interlock switches or any other part of the oven.

DO NOT remove outer panel from oven. Repairs must be done only by a qualified service person.

Smoke/Fire

If a fire occurs in the oven, press the Stop/Reset Pad and **KEEP THE DOOR CLOSED**.

Disconnect the power cord, or shut off the power at the fuse or circuit breaker panel.

Hot Surfaces

Exterior oven surfaces, including air vents on the cabinet and the oven door will get hot during use. (Convection and Combination) Take care when opening or closing door and when inserting or removing food and accessories.

The oven has heaters situated in the back of the oven. After use, the ceiling, walls and floor will be very hot.

Fan Motor Operation

After using MICROWAVE, CONVECTION and COMBINATION, the fan motor always rotates for approx. 5 minutes to cool the electric components. This is normal and you can take out food even though the fan motor is operating.

Storage of Accessories

When the oven is not being used, do not store any objects in case it is accidentally turned on. In case of electronic failure, the oven can only be turned off at the wall socket or breaker.

Interference

There is a possibility of a small amount of interference with weak broadcast signals if the oven is too close to a radio or TV.

General Use

DO NOT dry clothes, newspapers or other materials in oven, or use newspapers or paper bags for cooking. Fire could result.

DO NOT use recycled paper products unless the paper product is labeled as safe for microwave oven use.

Recycled paper products may contain impurities which may cause sparks, and result in fires when used.

DO NOT hit or strike control panel. Damage to controls may occur. Fire could result.

POT HOLDERS should always be used when removing items from the oven. Heat is transferred from the **HOT** food to the cooking container.

DO NOT store flammable materials next to, on top of, or in the oven. These could be fire hazards.

After the oven has been used for some time, the internal surface of the cavity may become permanently dark. Please note this condition is normal and it does not affect the oven's performance.

How to install the Air Screen

Before using the oven, please place the Air Screens to the front bottom skirt.

1. Pull the Pop Pin straight out.

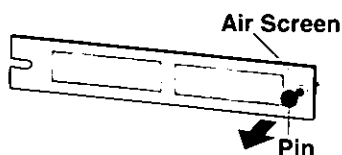

2. Align the screen with the center Post, hold the front of the Pop Pin forward, and insert the back of the pin into its hole. Press the front of the pin and it will pop into place.

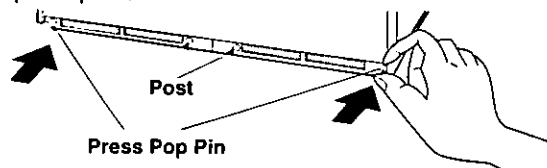

Outline Diagram

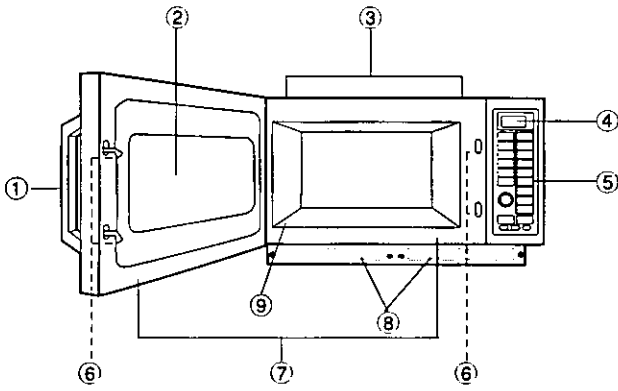

- ① Door Handle
- ② Oven Window
- ③ External Oven Air Vents (back of oven)
- ④ Display Window
- ⑤ Control Panel
- ⑥ Door Safety Lock System
- ⑦ Door Seal Area
- ⑧ Air Screen
- ⑨ Ceramic Base

Display Window

The cursor will illuminate and flash to indicate the function being set. Always check the cursor position before you press Start Pad.

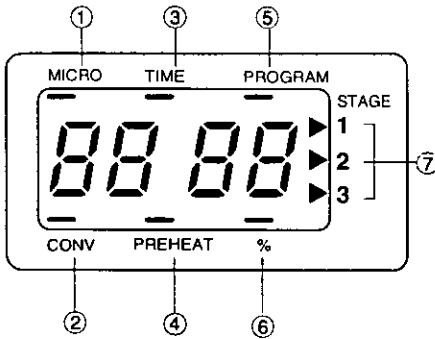

- ① Microwave Power
- ② Convection
- ③ Time
- ④ Preheat
- ⑤ Program
- ⑥ Microwave Power Level %
- ⑦ Cooking Stage Indicator

Control Panel

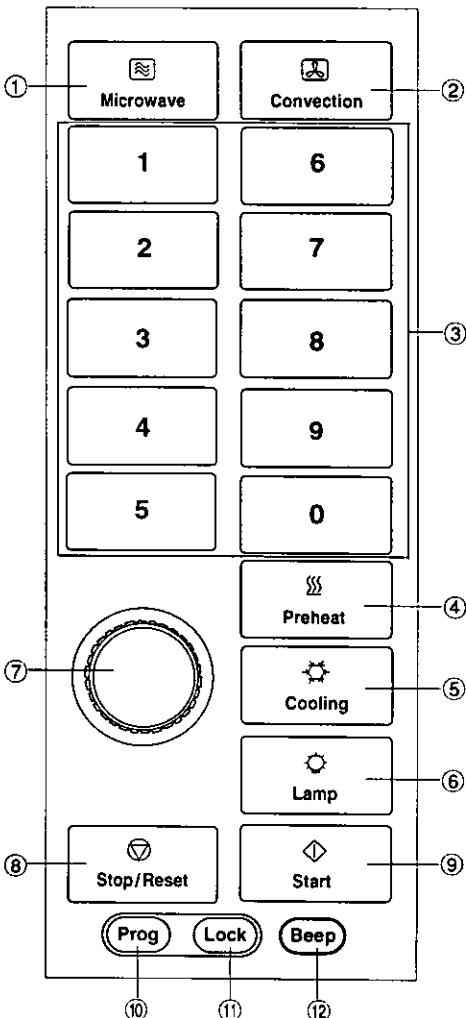

- ① Microwave Pad
- ② Convection Pad
- ③ Number Pads
- ④ Preheat Pad
- ⑤ Cooling Pad
- ⑥ Lamp Pad
- ⑦ Timer Dial
- ⑧ Stop/Reset Pad
- ⑨ Start Pad
- ⑩ Program Key
- ⑪ Program Lock Key
- ⑫ Beep Key

Operating Oven in Microwave mode

Example: To cook food at 60 % power for 4 min 30 sec

CONTROLS TO USE

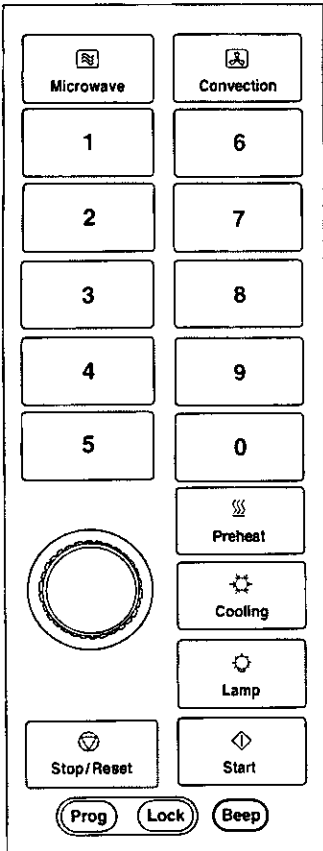

ACTION	INFORMATION	DISPLAY
1 Open Door. Put in Food. Close Door.	The oven lamp will come on. Oven lamp turns off.	
2 Press.	Press Microwave Pad. When heating at 100 % power, skip step 3.	
3 Select Power.	Press Number Pad.	
4 Select Time.	Turn Timer Dial to set a heating time. Max time you can set: 100-60 % 15 min 50-10 % 60 min	
5 Press Start Pad.	Display will count down time. The fan will be turned on.	
6 Open Door.	At end of cooking, oven beeps, and "0" flashes in display window until door is opened. Remove food. Display repeats program previously set.	End of Program Open Door

PRESS Number pad	DISPLAY (%)	WATTS (W)	PRESS Number pad	DISPLAY (%)	WATTS (W)
-----	100	1100		50	550
	90	990		40	440
	80	880		30	330
	70	770		20	220
	60	660		10	110

Note:

- The display window will go blank, one minute after cooking or during setting when the door is closed.

Operating Oven in Microwave mode

Multi-Stage (Sequential) Heating

The oven can be programmed with up to 3 different functions to operate in sequence. These can be MICROWAVE, CONVECTION or COMBINATION programs. If a required heating time is greater than 15 minutes on 100-60 % power, use 2 stage programming.

For 2 stage programming:

Repeat steps 1-4 on page 8 before then enter the next heating program, then press Start Pad.

For 3 stage programming:

Follow 2 stage programming and enter a 3rd heating program before pressing Start Pad.

2 stage programming

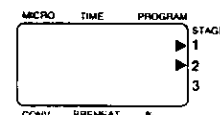

3 stage programming

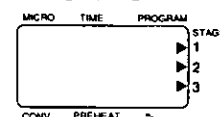

Changing the Heating Time

The heating time can be increased or decreased during cooking by turning Timer Dial.



Oven Lamp

The Oven Lamp switches off when the door is closed. If you want to check the food, press Lamp Pad, it will then illuminate for 10 seconds.

The Oven Lamp turns on and illuminates for 1 minute whenever the door is opened.

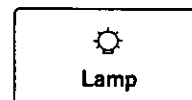

Repeat Feature

You can repeat the same heating program if you press Start Pad within 1 minute of the previous program finishing.

After 1 minute, if Start Pad is not pressed, the display returns to "0", or goes blank if the oven door is closed.



Stop/Reset Pad

Before heating: One tap clears the display.

During heating: One tap stops the heating cycle and two taps clear the display.

Note: See page 16 for operation while in Program Lock.

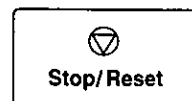

Operating Oven in Convection mode

Example: To cook food at 375°F for 18 minutes

CONTROLS TO USE

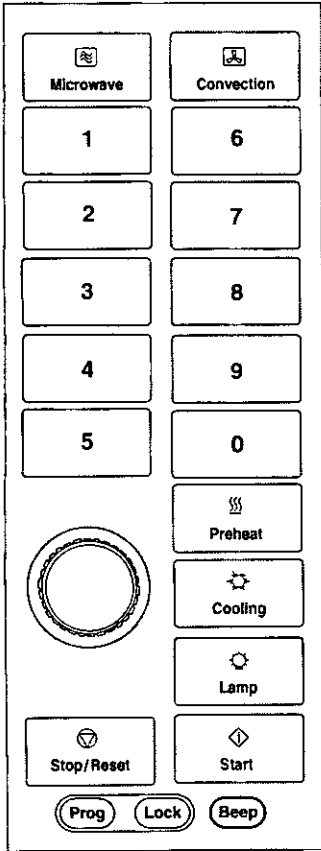

ACTION	INFORMATION	DISPLAY
If required, preheat oven to desired temperature. (See page 18.)		
1 Open Door. Put in Food. Close Door.	The oven lamp will come on. Oven lamp turns off.	
2 Press Convection Pad. 	Select required oven temperature. Continue to press Convection Pad until temperature required appears in display window. Temperature counts up in 25°F increments from 175°F-500°F	
3 Select Time. 	Turn Timer Dial to set a heating time. Max heating time: 2 h Timer counts up in: 30 s intervals 0-10 min 1 min intervals 10-60 min 10 min intervals 1 h-2 h	
4 Press Start Pad. 	Display will count down time. The Convection fan turns on.	
5 Open Door.	At end of heating program, oven beeps, and "0" flashes in display window until door is opened. Remove food. Display repeats program previously set.	End of Program Open Door

To switch between Celsius ("C") and Fahrenheit ("F"):

1 Open Door.	The display window must show "0". KEEP DOOR OPEN.
2 <u>While</u> pressing Start Pad, press and hold Convection Pad. 	"F" appears. ("C" appears.)
3 Keep pressing Start Pad and Convection Pad.	After 2 seconds, "C" appears. (After 2 seconds, "F" appears.) After 3 seconds, display returns to "0" or blank.

Operating Oven in Convection mode

Hot Surfaces

Exterior oven surface and the oven door is very hot after heating. Take great care when removing hot food. Use oven gloves.

Multi-Stage (Sequential) Heating

The oven can be programmed with up to 3 different functions to operate in sequence. These can be MICROWAVE, CONVECTION or COMBINATION programs.

For 2 stage programming:

Repeat steps 1-3 on page 10, enter the next heating program, then press Start Pad.

For 3 stage programming:

Follow 2 stage programming and enter a 3rd heating program before pressing Start Pad.

2 stage programming

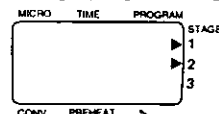

3 stage programming

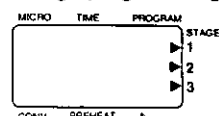

Changing the Heating Time

The heating time can be increased or decreased during cooking by turning Timer Dial.

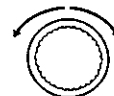

Recalling Set Temperature

The temperature selected can be checked during operation by pressing the Convection Pad. The temperature will be displayed in the display window before returning to the remaining heating time, when pressing the pad. The temperature cannot be altered during a program.

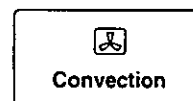

Oven Lamp

The Oven Lamp switches off when the door is closed. If you want to check the food, press Lamp Pad, it will then illuminate for 10 seconds. The Oven Lamp turns on and illuminates for 1 minute whenever the door is opened.

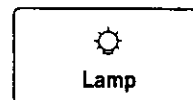

Repeat Feature

You can repeat the same heating program if you press Start Pad within 1 minute of the previous program finishing.

After 1 minute, if Start Pad is not pressed, the display returns to "0", or goes blank if the oven door is closed.



Stop/Reset Pad

Before heating: One tap clears the display.

During heating: One tap stops the heating cycle and two taps clear the display.

Note: See page 16 for operation while in Program Lock.



Preheat

For best results in convection mode the oven should be preheated. (See page 18.) It is useful to keep the oven condition fixed.

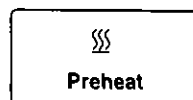

Operating Oven in Combination mode

Example: To cook food at 375°F and 30 % power for 12 minutes

CONTROLS TO USE

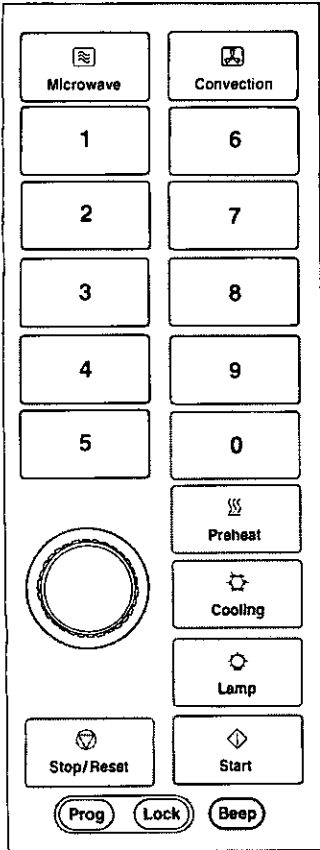

ACTION	INFORMATION	DISPLAY
If required, preheat oven to desired temperature. (See page 18.)		
<p>1 Open Door. Put in Food.</p> <p>Close Door.</p>	<p>The oven lamp will come on.</p> <p>Oven lamp turns off.</p>	
<p>2 Press Convection Pad.</p>	<p>Press Convection Pad until required temperature appears in display window.</p>	
<p>3 Press.</p> <p>Select Power.</p>	<p>Select Microwave power.</p> <p>Note: It is NOT possible to select 100-60 % power.</p>	
<p>4 Select Time.</p>	<p>Turn Timer Dial to set a heating time.</p> <p>Max heating time is: 1 h Timer counts up in: 30 s intervals 0-10 min 1 min intervals 10-60 min</p>	
<p>5 Press Start Pad.</p>	<p>Display will count down time. The fan turns on.</p>	
<p>6 Open Door.</p>	<p>At end of heating program, oven beeps, and "0" flashes in display window until door is opened.</p> <p>Remove food.</p> <p>Display repeats program previously set.</p>	<p>End of Program</p> <p>Open Door</p>

Operating Oven in Combination mode

Multi-Stage (Sequential) Heating

The oven can be programmed with up to 3 different functions to operate in sequence. These can be MICROWAVE, CONVECTION or COMBINATION programs.

For 2 stage programming:

Repeat steps 1-3 on page 12, enter the next heating program, then press Start Pad.

For 3 stage programming:

Follow 2 stage programming and enter a 3rd heating program before pressing Start Pad.

2 stage programming

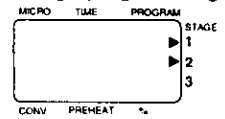

3 stage programming

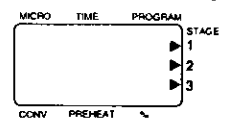

Changing the Heating Time

The heating time can be increased or decreased during cooking by turning Timer Dial.

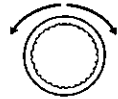

Oven Lamp

The Oven Lamp switches off when the door is closed. If you want to check the food, press Lamp Pad, it will illuminate for 10 seconds.

The Oven Lamp turns on and illuminates for 1 minute whenever the door is opened.

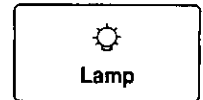

Repeat Feature

You can repeat the same heating program if you press Start Pad within 1 minute of the previous program finishing.

After 1 minute, if Start Pad is not pressed, the display returns to "0", or goes blank, if the oven door is closed.



Stop/Reset Pad

Before heating: One tap clears the display.

During heating: One tap stops the heating cycle and two taps clear the display.

Note: See page 16 for operation while in Program Lock.

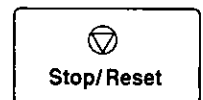

Preheat

For best results in combination mode the oven should be preheated. (See page 18.)

It is useful to keep the oven condition fixed.

For recalling set temperature see page 11.



Setting the Memory Programs

The oven has 100 blank programs capacity to meet your heating requirements.

Example: To program cooking food at 60 % power for 12 minutes into program 08

CONTROLS TO USE

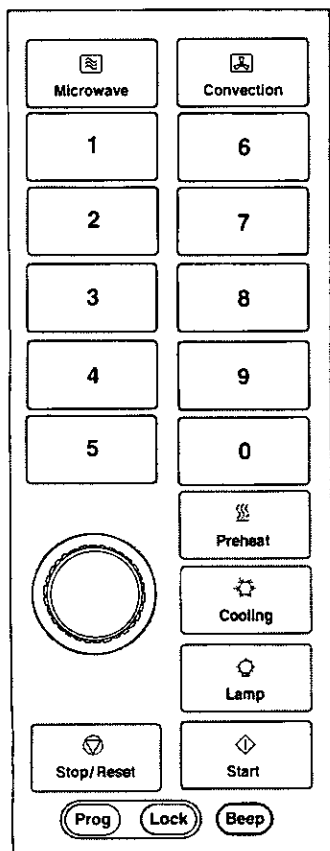

ACTION	INFORMATION	DISPLAY
1 Open Door.	The oven lamp will come on.	
2 Press Program Key. 	Keep key pressed for 2 seconds until "P" is displayed. KEEP DOOR OPEN	
3 Press Number Pad followed by 	Press Number Pads "0" and "8". If program has been previously set, this will appear in display window. If program memory is empty, then program number will appear in display window.	
4 Select Power. + 	Press Microwave Pad and Number Pad "6".	
5 Select Time. 	Turn Timer Dial until 12 min is displayed.	
6 Press Program Key. 	After 3 seconds display returns to "0".	

100 Memory Programs

Your oven has 100 blank programs. These can be used for your own heating requirements.

Program Lock

It is NOT possible to enter a program when Program Lock is set. (See page 17.)

Setting the Memory Programs

Multi-Stage (Sequential) Cooking



It is possible to program the memory to a 2 or 3 stage program using MICROWAVE, CONVECTION, or COMBINATION.

Changing a Memory Program

To change a program simply follow steps 1-6 as before, entering your new program.

Using the Memory Programs

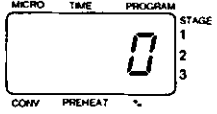
Example: To select program "08" in which your desired heating program (at 60 % power for 12 minutes) is set

ACTION	INFORMATION	DISPLAY
1 Open Door. Put in Food. Close Door	The oven lamp will come on. Oven lamp turns off.	 <p>The display shows '0' under the PROGRAM indicator. The STAGE indicator shows 1, 2, and 3. Labels MICRO, TIME, CONV, and PREHEAT are visible.</p>
2 Press Number Pad <div style="text-align: center; border: 1px solid black; width: 40px; height: 30px; margin: 0 auto; display: flex; align-items: center; justify-content: center;">0</div> followed by <div style="text-align: center; border: 1px solid black; width: 40px; height: 30px; margin: 0 auto; display: flex; align-items: center; justify-content: center;">8</div>	Press Number Pads "0" and "8".	 <p>The display shows '12:00' under the TIME indicator. The PROGRAM indicator shows '08'. The STAGE indicator shows 1, 2, and 3. Labels MICRO, TIME, CONV, and PREHEAT are visible.</p>
3 Press Start Pad. <div style="text-align: center; border: 1px solid black; width: 60px; height: 40px; margin: 0 auto; display: flex; align-items: center; justify-content: center;"> ◇ Start </div>	Display will count down time.	 <p>The display shows '11:59' under the TIME indicator. The PROGRAM indicator shows '08'. The STAGE indicator shows 1, 2, and 3. Labels MICRO, TIME, CONV, and PREHEAT are visible.</p>

Program Lock

If program lock is activated, cooking program starts immediately. There is no need to press Start Pad. (See page 16.)

Lock

How to activate the Program Lock

CONTROLS TO USE

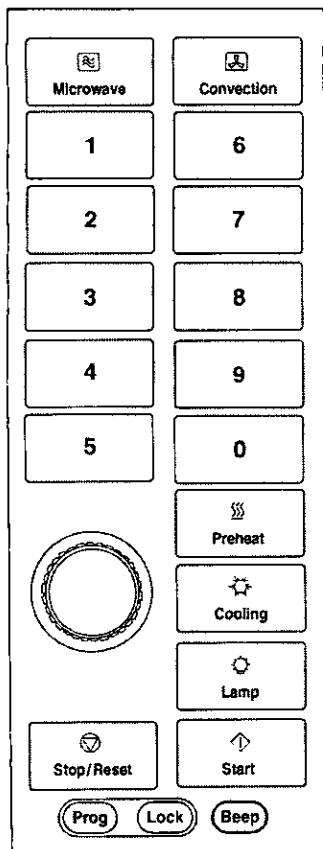

ACTION	INFORMATION	DISPLAY
1 Open Door.	The oven lamp will come on.	
2 Press Program Lock Key 	Keep key pressed for 2 seconds until "P" is displayed. KEEP DOOR OPEN. After 2 seconds, "P L" appears in display window. After 3 seconds, display reverts to "0".	

One Touch Operating Mode

When Program Lock is activated, oven operates in "ONE TOUCH" mode for program "00" to "09". Press required memory program number "0" to "9" and oven will immediately start.



There is no need to press Start Pad.

Note: When Program Lock is activated, it is NOT possible to use Program "10" to "99".

Setting New Programs

When the Program Lock is activated, it is not possible to enter a Memory Program, to change the Beep Tone or Preheat Temperature.

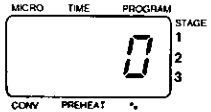
How to release the Program Lock

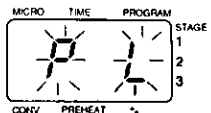
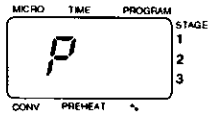
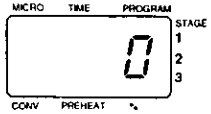
ACTION	INFORMATION	DISPLAY
<p>1 Open Door.</p>	<p>The oven lamp will come on.</p>	
<p>2 Press Program Lock Key.</p> <div style="text-align: center; margin: 10px 0;">  </div>	<p>Keep key pressed for 2 seconds until "P L" is displayed.</p> <p>KEEP DOOR OPEN.</p> <p>After 2 seconds, "P" appears in display window.</p> <p>After 3 seconds, display reverts to "0".</p>	  

Two Touch Operating Mode

The oven reverts to 2 Touch Operating mode for program "00" to "09".
 Press required memory program number then press Start Pad.

Setting New Programs

Once Program Lock is released, you can again enter new heating programs, change the Beep Tone and Preheat Temperature.











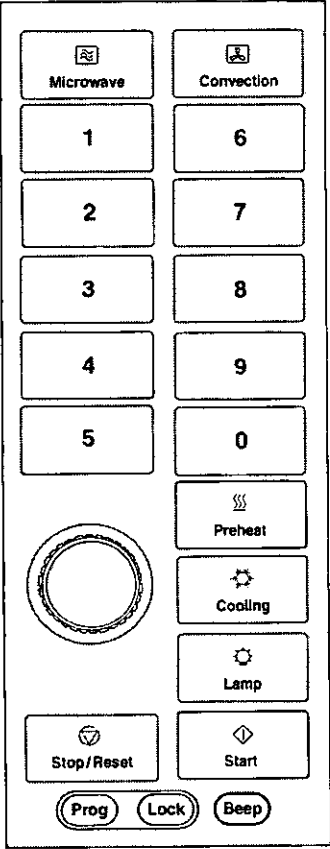

How to read the Program List

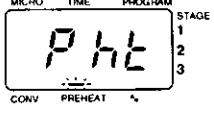
It is possible to check the programs that have been entered into the oven's 100 memory programs. With the door open, press Start Pad and Number Pad "1" simultaneously (the oven will make an acknowledging beep). After 2 seconds the display window will show each individual stage of each memory program in the order 00, 01, 02 etc. Finally it will display the Beep Tone setting, the program lock symbol (P L) and programmed hours for Scheduled Cleaning Service (see page 22) before clearing to "0".

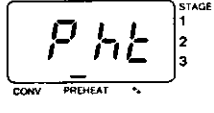
- * For example if you want to know what mode is programmed in 78,
1. After starting to show in the display from "00" press Stop/Reset Pad.
 2. Press Number Pads "7" and "8".
 3. Press Start Pad. (The display will show from program 78 through the following Program number.)

Keeping the Oven Hot

To assist in faster heating and browning results, the PREHEAT feature is designed to keep your oven at 425°F, 400°F or 350°F for a hot start before using CONVECTION or COMBINATION function.

CONTROLS TO USE	ACTION	INFORMATION	DISPLAY
	1 Press Preheat Pad. 	Select the required Preheat Temperature when display is blank or "0". eg. 350°F 1 press 425°F 2 presses 400°F 3 presses 350°F	
	2 Press Start Pad. 	Preheat Temperature will be maintained at the selected temperature. If not used, oven will automatically switch off after 1 hour. (Door must remain CLOSED.) Once oven has reached Preheat Temperature, "P" flashes and beep sounds.	 
	3 Open Door. Close Door Press Start Pad. 	Place food in oven. Select program. eg. Convection 375°F 15 min Display will count down time. At end of heating program, "0" flashes in display window and beep sounds until door is opened.	   
	4 Open Door.	Display window repeats program previously set. If Start Pad is not pressed within 1 minute, oven reverts to PREHEAT.	 After 1 minute 

Notes on Preheat and Cooling:



- AFTER heating function has completed, oven will revert to PREHEAT function automatically.
- If you want to cancel PREHEAT function, keep Stop/Reset Pad pressed for 2 seconds.
- During PREHEAT or COOLING, if you have started from a blank display and want to select another function pad, open the door first before selecting a function.

Keeping the Oven Hot

Limit Time for Preheat Function

PREHEAT function is preset to limit to 60 minutes, at the factory.

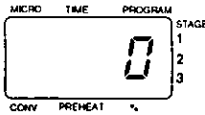
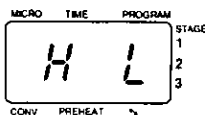
You can change the program to keep oven hot endlessly, by using the following instructions.

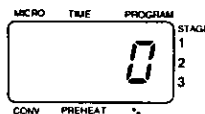
ACTION	INFORMATION	DISPLAY
1 Open Door.	The oven lamp will come on.	
2 While pressing Start Pad, press and hold Cooling Pad. <div style="display: flex; align-items: center; justify-content: center; gap: 10px;"> <div style="border: 1px solid black; padding: 2px 5px; text-align: center;">◊ Start</div> <div>+</div> <div style="border: 1px solid black; padding: 2px 5px; text-align: center;">❄️ Cooling</div> </div>	"H L" appears. KEEP DOOR OPEN.	
3 Keep pressing.	After 2 seconds, "H E" appears. After 3 seconds, display returns to "0".	 

* If you want to revert the PREHEAT function to limit to 60 minutes:

1. Open the door and leave it open.
2. While pressing Start Pad, press and hold Cooling Pad until "H E", then "H L" appears in the display window.

Cooling the Oven quickly

To quickly cool the oven cavity, the oven has a Cooling Pad. The Cooling Pad can be used for defrosting or heating by Microwave while in PREHEAT mode.

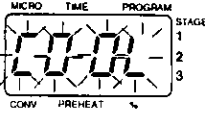
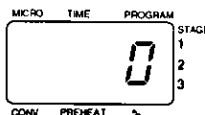
ACTION	INFORMATION	DISPLAY
1 Press Cooling Pad. <div style="display: flex; align-items: center; justify-content: center; gap: 10px;"> <div style="border: 1px solid black; padding: 2px 5px; text-align: center;">❄️ Cooling</div> </div>	Press Cooling Pad when the display is blank or "0".	
2 Press Start Pad. <div style="display: flex; align-items: center; justify-content: center; gap: 10px;"> <div style="border: 1px solid black; padding: 2px 5px; text-align: center;">◊ Start</div> </div> <p>Once the oven has cooled.</p>	<ul style="list-style-type: none"> • The COOLING fan and CONVECTION fan will turn on. • The oven door can be opened or closed. But the oven can be cooled faster when the door is opened than closed. • The oven will cool in 2-30 min depending on temperature. <p>The COOLING and CONVECTION fans switch off.</p>	 

How to change the Beep Tone

When Program Lock is activated, you can not change the Beep Tone.
Please release the Program Lock. (See page 17.)

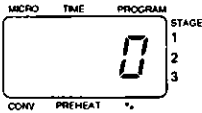
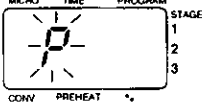
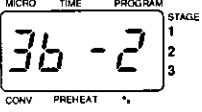
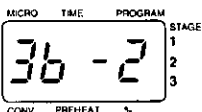
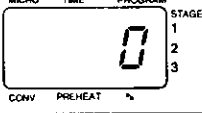
ACTION	INFORMATION	DISPLAY
1 Open Door.	The oven lamp will come on.	
2 Press Program Key. <div style="text-align: center; border: 1px solid black; border-radius: 15px; padding: 5px; width: fit-content; margin: 0 auto;">Prog</div>	Keep key pressed for 2 seconds until "P" is displayed. KEEP DOOR OPEN.	
3 Press Beep Key. <div style="text-align: center; border: 1px solid black; border-radius: 15px; padding: 5px; width: fit-content; margin: 0 auto;">Beep</div>	Press Beep Key to choose loudness and duration required. (See below.) (eg. twice)	
4 Press Program Key. <div style="text-align: center; border: 1px solid black; border-radius: 15px; padding: 5px; width: fit-content; margin: 0 auto;">Prog</div>	After 3 seconds Display returns to "0".	 After 3 seconds 

The loudness of Beep Tone and its duration at the end of heating cycle can be set.
There are four levels of the loudness and three levels of duration.
The 3b-1 is preset at the factory.

No.Presses	Display	loudness	duration
<div style="border: 1px solid black; border-radius: 15px; padding: 2px 5px;">Beep</div>			
1	3b-1	Loudest	beeps for 60 seconds
2	3b-2	Loudest	short beeps 3 times
3	3b-3	Loudest	long beeps 3 times
4	2b-1	Middle	beeps for 60 seconds
5	2b-2	Middle	short beeps 3 times
6	2b-3	Middle	long beeps 3 times
7	1b-1	Quietest	beeps for 60 seconds
8	1b-2	Quietest	short beeps 3 times
9	1b-3	Quietest	long beeps 3 times
10	0b	Silent	---

How to read the Cycle Counter

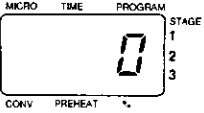
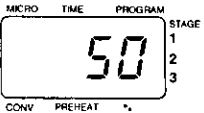

◆ To read total cumulative cycles that the oven has been used:

ACTION	INFORMATION	DISPLAY
<p>1 Open Door.</p> <p>Keep Door Open.</p>	The oven lamp will come on.	
<p>2 While pressing Start Pad, press Microwave Pad.</p> <div style="display: flex; align-items: center; justify-content: center; gap: 10px;"> <div style="border: 1px solid black; padding: 2px 5px; text-align: center;">↕ Start</div> <div>+</div> <div style="border: 1px solid black; padding: 2px 5px; text-align: center;">Microwave</div> </div>	<p>$1/100$ of the total number of cumulative cycles that the oven has been used in Memory Programs and Manual mode will appear. eg. 5000 cycles After 3 seconds, display returns to "0" or blank.</p>	

Note:

- Any cycles less than 100 do not show.

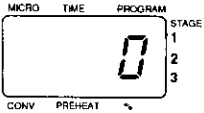
◆ To read total hours that the oven has been used:

ACTION	INFORMATION	DISPLAY
<p>1 Open Door.</p> <p>Keep Door Open.</p>	The oven lamp will come on.	
<p>2 While pressing Start Pad, press Number Pad "5".</p> <div style="display: flex; align-items: center; justify-content: center; gap: 10px;"> <div style="border: 1px solid black; padding: 2px 5px; text-align: center;">↕ Start</div> <div>+</div> <div style="border: 1px solid black; padding: 2px 5px; text-align: center;">5</div> </div>	<p>$1/100$ of the total number of hours that the oven has been used or kept hot will appear. eg. 15000 hours After 3 seconds, display returns to "0" or blank.</p>	

Note:

- Any hours less than 100 do not show.

◆ To check the number of cycles that the oven has been used in Manual Mode:

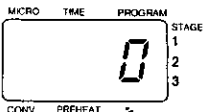
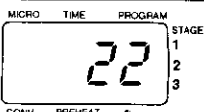
ACTION	INFORMATION	DISPLAY
<p>1 Open Door.</p> <p>Keep Door Open.</p>	The oven lamp will come on.	
<p>2 While pressing Start Pad, press Number Pad "6".</p> <div style="display: flex; align-items: center; justify-content: center; gap: 10px;"> <div style="border: 1px solid black; padding: 2px 5px; text-align: center;">↕ Start</div> <div>+</div> <div style="border: 1px solid black; padding: 2px 5px; text-align: center;">6</div> </div>	<p>$1/100$ of the number of cycles that the oven has been used in manual mode will appear. eg. 2250 cycles After 3 seconds, display returns to "0" or blank.</p>	

Note:

- Any cycles less than 100 do not show.

How to program for Scheduled Cleaning Service







Schedule Cleaning Service

For the Exhaust Duct, Heater Unit and Oil Pan inside the oven, it is recommended to schedule Cleaning Service. (See page 26.)

When "FC 9" sign appears in the display window, have cleaning service performed by an authorized service person.

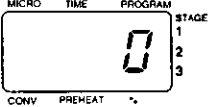
FC 9

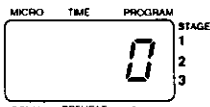

◆ To program hours for scheduled cleaning service:

ACTION	INFORMATION	DISPLAY
1 Open Door.	The oven lamp will come on.	
2 While pressing Start Pad, close and open Door. <div style="text-align: center; border: 1px solid black; padding: 2px; width: 60px; margin: 0 auto;">  Start </div>		
3 Press Number Pad "3". <div style="text-align: center; border: 1px solid black; padding: 2px; width: 60px; margin: 0 auto;"> 3 </div>	1/100 of the currently programmed hours will appear. eg. 30000 hours	
4 Select time. <div style="text-align: center; margin: 0 auto;">  </div>	Turn Timer Dial to set desired hours for scheduled cleaning service. eg. 1500 hours	
5 Press Program Key. <div style="text-align: center; border: 1px solid black; border-radius: 50%; padding: 5px; width: 60px; margin: 0 auto;"> Prog </div>	3 seconds later, display reverts to "0" or blank.	

Notes:

- 30000 hours is preset for Scheduled Cleaning Service at the factory.

◆ To clear "FC 9" sign the total hours counter:

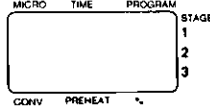
ACTION	INFORMATION	DISPLAY
		
1 While pressing Start Pad, press Number Pad "5". <div style="display: flex; align-items: center; justify-content: center; gap: 10px;"> <div style="border: 1px solid black; padding: 2px; text-align: center;">  Start </div> + <div style="border: 1px solid black; padding: 2px; width: 40px; text-align: center;"> 5 </div> </div>	Display reverts to blank.	

Sanitary Counter Top Seal

When oven is placed on a counter top, its base must be sealed in accordance with N.S.F.

Standards as per the following instructions.

1. Oven should be located on a level counter top surface. Complete the electrical connections.
2. Thoroughly clean and sanitize the oven bottom perimeter and the counter top area around the oven perimeter.
3. Remove the Air Screens from the front of the oven before applying high temp. silicone.
4. Lay generous bead of high temp. silicone seal around the entire perimeter of the base of each oven unit.
5. Smooth the silicone seal into the crevice with your finger or tool to provide a cove seal.

Note: DO NOT FORGET to re-install the Air Screens after applying high temp. silicone.

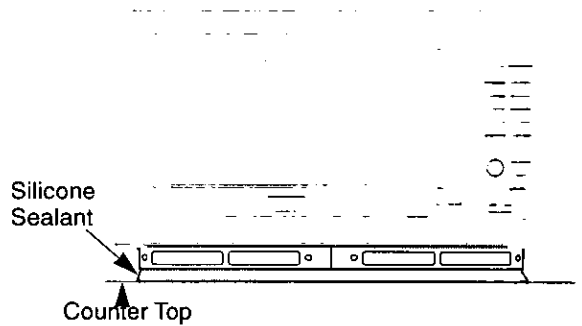

Self Diagnostics Failure Code Explanation

Your oven is equipped with a Self Diagnostic Failure Code System: This means the oven monitors its own operation and will show a Failure Code in the display window in the unlikely event of a malfunction.

If a Failure Code appears in the display window, follow these steps:
(It will appear as an "F" then a two digit number)

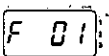
eg. 

1. Close the door and unplug the oven at the main socket. Ensure all air vents are clear.
2. Leave 1 minute and then reconnect the oven at the main socket.
3. Open the door and place food or a jug of water in the cavity, close the door.
4. Try the same function that had been in operation prior to the appearance of the Failure Code in the display window.

If the Failure Code appears again, then contact the dealer from whom you purchased the oven.

What to do when a failure code appears:

CODE	CAUSE	WHAT TO DO
F01	<ul style="list-style-type: none"> • Overcooked food. • Temperature of exhaust air too high. 	<ul style="list-style-type: none"> • Unplug the appliance to stop beeping. • Wait for appliance to cool down to reset operation. • If food ignites, do not open the door. • If normal operation does not resume, call the service agent with information of failure code.
F05	• Defective Memory IC.	<ul style="list-style-type: none"> • Unplug the appliance and wait more than 1 minute and reconnect. • If normal operation does not resume, call the service agent with information of failure code.
F30	• Defective thermistor circuit.	
F44	• Defective control panel.	
F09	• Incoming line frequency is not matched.	<ul style="list-style-type: none"> • Check line frequency and reconnect to the right power source.

Taking Care of Your Oven

It is essential that you follow these points to get the maximum use from your oven. Microwaves are attracted to moisture and grease, therefore a dirty oven does not cook EFFICIENTLY.

Caution: Do not clean this oven with any product that is labeled as containing corrosive chemicals.

The heating of corrosive chemicals in this oven may cause microwave radiation leaks.

DO NOT clean this oven by spraying with water.

1. Before Cleaning

Unplug the oven at the socket.

2. Door Seals

Pay special attention to cleaning the door seals and door seal areas.

Regularly wipe the Drip Ledge to avoid a build up of moisture and grease.

3. Door

Keep the inside glass of the door clean by wiping regularly with a soft damp cloth. Small amounts of oven cleaner can be used—DO NOT SPRAY DIRECTLY onto door—spray onto a cloth and wipe oven. Do not use harsh detergents or abrasives.

4. Oven Walls

The walls should be wiped regularly with a soft damp cloth. Small amounts of oven cleaner can be used—DO NOT SPRAY DIRECTLY onto walls—spray onto a cloth and wipe.

DO NOT ALLOW OVEN CLEANER NEAR THE HOLES IN THE WALL OF THE OVEN. If corrosive cleaner gets behind the oven wall, your oven could be damaged. Do not allow cleaning liquids to seep into openings.

Excess grease can be softened for ease of cleaning by placing 500 - 800 ml of hot water in a microwave-safe bowl with a chopped fresh lemon. Heat on 100 % Power for 15 - 20 min. The moisture produced on the walls should be wiped with a soapy cloth.

5. Oven Floor

The wave guides are situated beneath the ceramic base of the oven. Any spills must therefore be wiped clean to ensure even heating. Do not use harsh detergents or abrasives.

Taking Care of Your Oven

6. Ceiling

Before cleaning, ensure oven has cooled to avoid burns. Wipe the ceiling regularly with a damp cloth to minimize build up of grease and smoke.

7. Control Panel

If the Control Panel becomes dirty, clean with a soft, dry cloth. Do not use harsh detergents or abrasives on Control Panel. Do not use a saturated cloth as the remaining moisture may damage the panel. When cleaning the Control Panel, keep the oven door open to prevent the oven from accidentally turning on. After cleaning, touch Stop/Reset Pad to clear display window.

8. Replacement of the Oven Lamp

If the Oven Lamp burns out, it can be replaced by following these directions.

1. Unplug the oven.
2. Remove the screw and the Oven Lamp Cover which is located on the left side of the cabinet.
3. Replace the old bulb with a new one.
(use 220/240 V, 25 W max., E-14 lamp.)
4. Reinstall the Oven Lamp Cover.

Caution: Remove the plug from the electrical socket before replacement of the Oven Lamp Bulb.

Taking Care of Your Oven

9. Cleaning the Air Screen

Clean the Air Screens occasionally according to the following instructions. Problems may occur with the oven if the screens become clogged with dirt or dust.*

1. Remove the right Air Screen from the front bottom skirt by pulling the Right Pop Pin straight out. Then slide the screen to the right and lift it off the post at the center.

Remove the left Air Screen the same as right one.

2. Wash the screens with soap and water.

3. To replace, align the screen with the center post, hold the front of the Pop Pin forward, and insert the back of the pin into its hole. Press the front of the pin and it will pop into place. Be sure to replace the Air Screens before using the oven.

*If the Air Screen becomes clogged with dust or grease, it may cause an overheating problem in the oven.

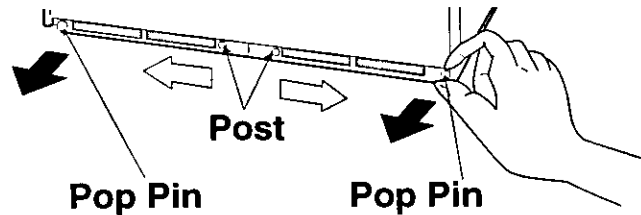

10. Cleaning Service Schedule

For the Exhaust Duct, Heater Unit and Oil Pan inside the oven, it is recommended to schedule Cleaning Service by an authorized service person every 6 months, or when a heavy grease buildup is seen on the back of the oven cavity. This is NOT covered under warranty.

How does the Microwave work?

Microwaves are a form of high frequency radio waves similar to those used by a radio including AM, FM and CB. They are, however, much shorter than radio waves; approximately five inches in length. Electricity is converted into microwave energy by the magnetron tube. From the magnetron tube, microwave energy is transmitted to the oven cavity where it is: reflected, transmitted and absorbed.

1. Reflection

They will REFLECT off metal. The inner walls of your oven are made of stainless steel, so that the microwave energy can bounce evenly around the cavity. Of course, the microwaves will also reflect off metal cooking containers and accessories, such as saucepans and platters.

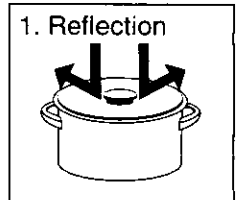

2. Transmission

The microwaves will TRANSMIT through paper, plastic, glass and china, therefore, containers made of these substances should be used in microwave cookery.

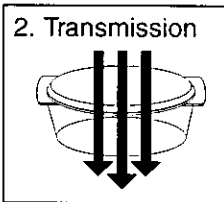

3. Absorption

The microwave energy is ABSORBED by the food. The energy penetrates the food causing the molecules to vibrate over 2,450,000,000 times a second. This vibration causes the water molecules to rub against each other producing frictional heat which cooks the outer part of the food; the heat is then conducted through the food to cook the center.

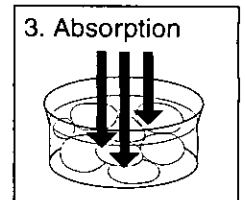

Types of Containers to use

Before use, the user should check that utensils are suitable for use in your oven. Do not use any closed jar for Microwave or Combination. Pressure will build up and the jar may explode.

MICROWAVE

1. Glass

DO USE: Heat Resistant glass eg. Pyrex
DO NOT USE: Delicate glass, lead crystal which may crack or arc.

2. China/Ceramics

DO USE: Glazed china dishes, porcelain and ceramic dishes designed for cooking.
DO NOT USE: Fine bone china dishes with metal patterns. Jugs with glued handles.

3. Pottery/Earthenware/Stoneware

DO USE: If completely glazed.
DO NOT USE: If unglazed—these dishes can absorb water which absorbs energy. This makes the dish hot and increases the heating time.

4. Foil/Metal

DO USE: For reheating only: Individual portion, open topped foil containers. Make sure the containers do not touch WALLS or DOOR of oven. Do not cook in foil containers. Small amounts of Aluminium foil can be used to shield joints of meat during defrosting—make sure that foil does not touch sides or door.
DO NOT USE: Metal platters, Wire Rack Shelf, any dish with METAL PATTERN or TRIM. METAL SKEWERS. DO NOT REUSE FOIL CONTAINERS—ARCING may occur as they become DENTED/DAMAGED. Do not use Le Creuset style dishes (Cast iron covered by enamel). These can be used on convection.

5. Plastics

DO USE: High temperature plastics like Durable Polysulfon plastics and "H" pans rather than soft flexible dishes, Roasting bags. (Remove any metal twist ties.)
DO NOT USE: Melamine, Polypropylene, Phenol Urea, also do not use plastic food storage bags and containers eg. Margarine, Yogurt and Mayonnaise tubs.

6. Covering Films

DO USE: Non plastic cling film designed for Microwave use. Do not allow film to touch food. To prevent severe steam burns, pierce film to allow steam to escape and remove film from dish carefully.
DO NOT USE: Film designed only for covering food.

7. Wood/Wicker

DO USE: Wooden skewers designed for food use.
DO NOT USE: Wicker baskets, wooden bowls (with prolonged use these tend to dry out and may ignite)

8. Paper

DO USE: Disposable, polyester coated paper board dishes if designed for microwave.
DO NOT USE: Paper napkins (these can ignite), wax coated cups, recycled products (unless stated suitable by manufacture)

COMBINATION

Combination programs use Microwave and Convection, therefore you must choose the container carefully.

DO USE: Metal containers that do not have jagged metal seams. Ceramics that do not have a metal pattern. Heat proof glass and china.
DO NOT USE: Enamelled items (that may be chipped). Dishes with gold/metal pattern. Enamelled cast iron, eg. Le Creuset. Any dish that is not heat proof, eg. plastics, and cling film.

CONVECTION

DO USE: Any container suitable for conventional ovens, eg. metal, ceramic, earthenware, enameled cast iron etc.
DO NOT USE: Plastic containers, food films, wood/wicker, glass, paper

Cooking Instructions

COOKING BASICS

Fundamental principles determine the success of microwave food preparation.

They include:

1. Always cook or heat foods in covered containers.
- This will accomplish the following:
 - a) Retain steam to keep foods moist.
 - b) Cause even cooking temperatures.
 - c) Keep the interior of the oven clean.
2. **TEMPERATURE OF FOODS** — Frozen food items will require longer heating times to reach a desired serving temperature than foods that are refrigerated.
3. **FOOD COMPONENTS** — Foods high in sugar, salt, fats and moisture content heat faster because these properties attract microwave energy. Denser foods high in protein and fiber, absorb microwave energy slower which means a lengthier heating time.
4. **BULK/VOLUME** — The greater the mass of food, the longer it takes to heat.
5. **CONTAINERS** — Ceramic, paper, china, styrofoam, glass and plastic are suitable for use in microwave ovens with the following caution.
DO NOT HEAT foods in a **SEALED** container or bag. Foods expand when heated and can break the container or bag.

Heating foods with either high sugar or high fat content should be done **ONLY** in high temperature-resistant containers since these foods get very hot. Using styrofoam containers for these foods will cause the styrofoam to warp. Other low temperature restaurant glass or plastic platters may crack or warp under similar conditions.

6. **DO NOT USE HIGH-SIDED METAL CONTAINERS** because it "bounces" the microwaves, causing uneven heating and sometimes even flashes, which may pit or mark the interior of the oven, the metal container or plate trim. Use 1/4 size sheet pans or other low-sided containers.
7. Heated liquids can erupt if not mixed with air. Do not heat liquids in your microwave oven without first stirring. (See #1)

GENERAL GUIDELINES FOR STEAMING IN A PANASONIC COMBI - WAVE™

Please refer to the USDA/FDA Food Code guidelines.

COOKING FOODS FROM REFRIGERATED TEMPERATURE

Foods stored in the refrigerator (40°F) should be covered before reheating with the exception of breads, pastries or any breaded product, which should be heated uncovered to prevent sogginess.

Most conventionally prepared foods should be slightly undercooked, and held in the refrigerator, so that overcooking does not occur during microwave cooking. *

Cooked items, such as vegetables, may be portion plated and covered for reheating without loss of color, texture or nutritional content.

COOKING FOODS FROM ROOM TEMPERATURE

Food items such as canned entrees, vegetables, etc. will require significantly less cooking time than those from refrigerated temperatures.

IMPORTANT RECOMMENDATIONS

1. For best results it is recommended that foods conventionally prepared be slightly undercooked when subsequently heated in this oven. *
2. **REMEMBER** that after the cooking cycle has been completed, internal food temperatures continue to rise slightly in foods heated in this oven.
3. A major mis-use of microwave applications is the category of breads, pastries and pies. Their crusts and outsides are drier than insides or fillings, they heat more slowly. Therefore, baked goods should **ONLY** be heated until the crust is warm to the touch (120°F-130°F). *
4. **DO NOT OVERHEAT YOUR FOOD: 99% of all food quality complaints of microwave heated foods can be traced to overheating.**

*For only **non** "Potentially Hazardous Foods" (PHF) vegetables, etc. - Please always adhere to USDA/FDA guidelines when cooking and reheating PHF.

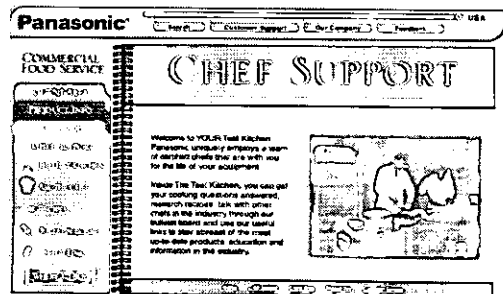
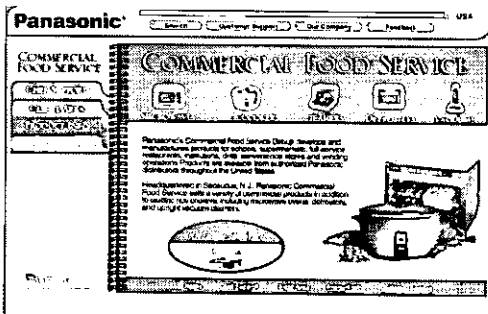

Recipes available on www.panasonic.com/cmo (See page 2 for Chef Support)

Technical Specifications

Model	NE-C1153	
Power Source	208 V / 60 Hz, single phase	
Required Power	3900 W / 18.8 A	
Output	Microwave:	1100 W (IEC 705-88)
	Convection Heater:	2800 W
Frequency	2450 MHz	
Outer Dimensions (W x D x H)	23 ⁵ / ₈ " x 20 ⁷ / ₁₆ " x 15 ³ / ₁₆ " (600 mm x 519 mm x 385 mm)	
Cavity Dimensions (W x D x H)	16" x 13 ¹ / ₄ " x 8 ⁹ / ₁₆ " (406 mm x 336 mm x 217 mm)	
Net Weight	88 lbs (40 kg)	
Timer	Microwave: 100 - 60 % power	15 minutes
Maximum Setting Time	50 - 10 % power	60 minutes
	Convection: 2 hours	Combination: 1 hour
Memory Programs	100 Memory Programs	

Specifications subject to change without notice.

For the voltage requirements, the production year and month, country and serial number, please refer to the identification plate on the Microwave Convection Oven.

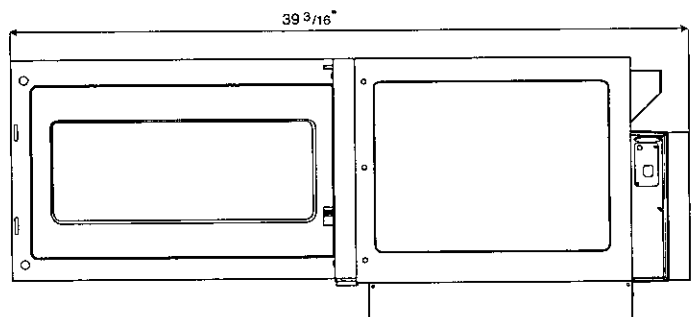
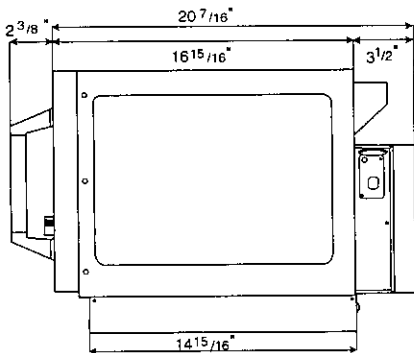
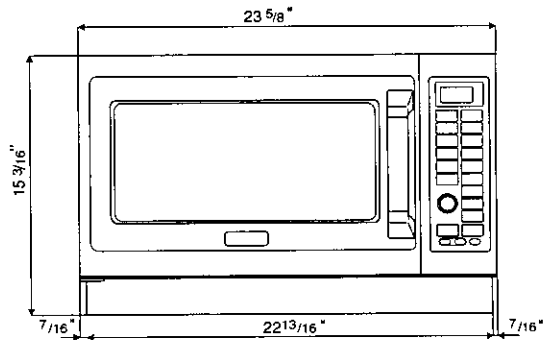

Memo

Panasonic®

www.panasonic.com/cmo

**PANASONIC HOME AND COMMERCIAL
PRODUCTS COMPANY, DIVISION OF
MATSUSHITA ELECTRIC CORPORATION
OF AMERICA**

One Panasonic Way 4A-4
Secaucus, NJ07094
Or Call (201) 348-5377

A00033840AP
F1101-0
Printed in Japan